

### Technical Specifications

Dimensions	MPD.1012
<b>A</b> — Working Height	10,00 m
<b>B</b> — Platform Height— lifted	8,00 m
<b>D</b> —Platform Height— Lowered	1,40 m
<b>D+C</b> — Height—Stowed folding guardrails	2,50 m
Height—Stowed rails folded	1,85 m
<b>C</b> —Guardrail Height	1,10 m
<b>ExF</b> — Platform Dimensions	2,30 x 1,15 m
<b>K</b> — Extension Deck	1,00 m
<b>G</b> — Platform Width	1,15 m
<b>L</b> — Total Length	2,50 m
<b>J</b> — Wheelbase	1,90 m
Ground Clearance — Center	10 cm
Ground Clearance with pothole guards deployed	1,90 cm
Productivity	
Lift Capacity	400 kg
Extension Deck Capacity	120 kg
Maximum Platform Occupancy	2
Raise / Lower Speed	45 / 55 sn
Weight	2300 kg
Grade ability	%20
Drive Speed (Raised / Stowed)	0,8 / 2,4 km
Tyres—Solid non-marking	381×127 mm
Turning Radius	2500 mm
Power	
Power Source	24 V Battery
Lifting System / Drive Type	24 V Battery
Battery	4x6V 242 Ah
Charger	24V 30 Ah

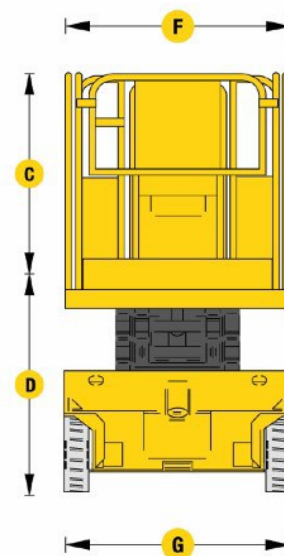
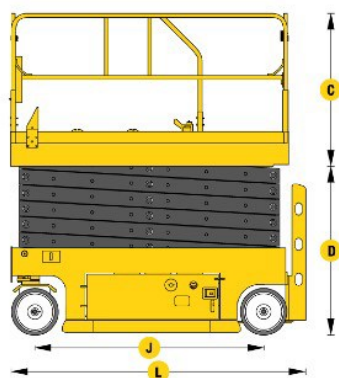
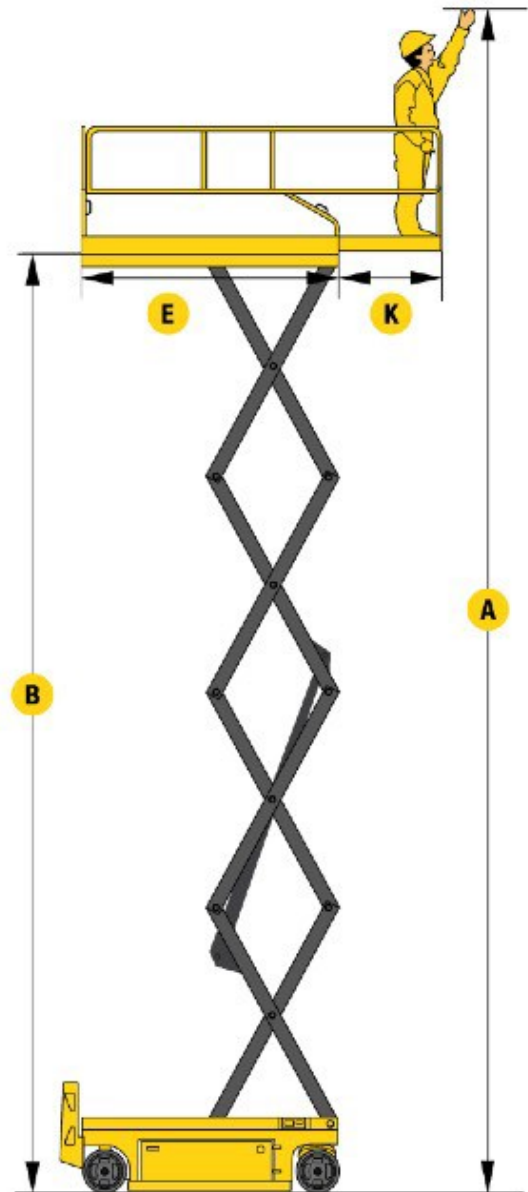

### Measurements

- 10,0 m working height
- 400 kg lifting capacity

### Platform

- 2,30x1,15 m platform
- 1,0 m deck extension

### Lifting Type

- 24V Battery

### Drive Type

- 24V Battery

### Optional

- Airline to platform
- AC Power on the platform
- Platform work lights
- Special customer paint

### Platform

- Roll-out deck extension
- Drivable at full height
- Fold down handrails
- Self lock gate on platform
- Removable platform console box
- Lanyard attach points
- Full proportional drive joystick control
- Proportional lift/lower speed control
- Overload sensor

### Power and Transmission

- 4x6V 242 Ah deep cycle batteries
- Swing-out battery/electrical compartment doors
- 30 Amp automatic battery charger
- Charger protection with data charging data details
- Dual motor direct hydraulic front wheel drive & steer
- 2WD
- Dual rear wheel automatic hydraulic brakes
- Emergency brake release

### Functional Equipment & Accessories

- Automatic pothole protection system
- Emergency lowering system
- On-board diagnostic system
- Battery condition indicator
- Hour meter
- Lubrication free scissor arm bushing
- Scissor maintenance bar
- Cylinder holding valve
- Manual descent
- Horn
- Non-marking solid tyres
- Slope motion cut out
- All motion alarm
- Descent alarm
- Tie down lugs
- Forklift pockets
- Tilt level sensor with audible alarm



### ONDLIFT Mak. San. Tic. Ltd. Şti

**Factory:** Organize Sanayi Bolgesi 2004 Cad. No: 4  
Turgutlu/Manisa/TURKEY

**Showroom:** İmes San. Sit. C.302 Sk. No:13  
Y.Dudullu/Umraniye/Istanbul/TURKEY

Tel: 0090 236 332 5050

ondlift@ondlift.com

Product specifications are subject to change without any notice or obligation. The photographs and/or drawing in this documents are for illustrative purpose only. All productions of OndLift, manufacturing for CE standards.

**Turkey**  
Discover  
the potential

Onder Lift Celik



**43rd Years Anniversary**

Your warehous partner

Onder Grup Company